



415 Broadway
Oklahoma City
Oklahoma 73102
V.405.232.8787
www.tapokc.com

MOORE CITY HALL RENOVATION

301 N BROADWAY
MOORE, OKLAHOMA 73160

PROJECT NO: 2227

DATE: 02/10/2025

FURNITURE PACKAGE FOR: CITY OF MOORE CITY HALL RENOVATION

BID NO. 2025-010

CITY OF MOORE
CLEVELAND COUNTY, OKLAHOMA

CLIENT

CITY OF MOORE
BROOKS MITCHELL
301 N BROADWAY
MOORE, OK 73160
405.793.5000

ARCHITECT

TAP ARCHITECTURE
PROJECT ARCHITECT: ANTHONY MCDERMID
PROJECT MANAGER: CLAY DOBBINS
PROJECT DESIGNER: SANDRA PERKINS
415 N BROADWAY AVE
OKLAHOMA CITY, OKLAHOMA 73102
405.232.8787

FURNITURE CONSULTANT

GLOBAL FURNITURE
UNDER THE DIRECTION OF: JILL BAUMAN
PHONE: 405.230.7850
EMAIL: jbauman@officeinteriorsok.com
204 N ROBINSON AVE, STE 1900
OKLAHOMA CITY, OKLAHOMA 73102



NOTE:
 • DEALER TO FIELD MEASURE AND VERIFY ALL COMPONENTS FIT WITHIN ALLOTTED AREAS

DRAWN TO DEALER PROVIDED SPECIFICATIONS. THE GLOBAL GROUP OF COMPANIES IS NOT RESPONSIBLE FOR THE OVERALL ACCURACY OF ROOM DIMENSIONS, COLUMNS, DOORWAYS, WINDOWS, OBSTRUCTIONS, ETC. THIS RENDERING IS BEING PROVIDED TO YOU IN CONJUNCTION WITH THE PROSPECTIVE RETAIL SALE OF PRODUCTS AND IS FOR INFORMATIONAL PURPOSES ONLY. THE GLOBAL GROUP OF COMPANIES IS NOT A LICENSED INTERIOR DESIGNER OR ARCHITECT.

CITY OF MOORE CITY HALL
 AREA C – OVERALL
 MERRIFIELD OFFICE SUPPLY

SPECIFICATION DEPARTMENT
 global furniture group
 globalfurnituregroup.com
 globaladpartalia.com
 evolvefurnituregroup.com



PREPARED BY
 BJ
 DATE
 5.04.24
 PROJECT NUMBER
 S93706
 REVISION
 18

SHEET
 1
 SCALE = NTS

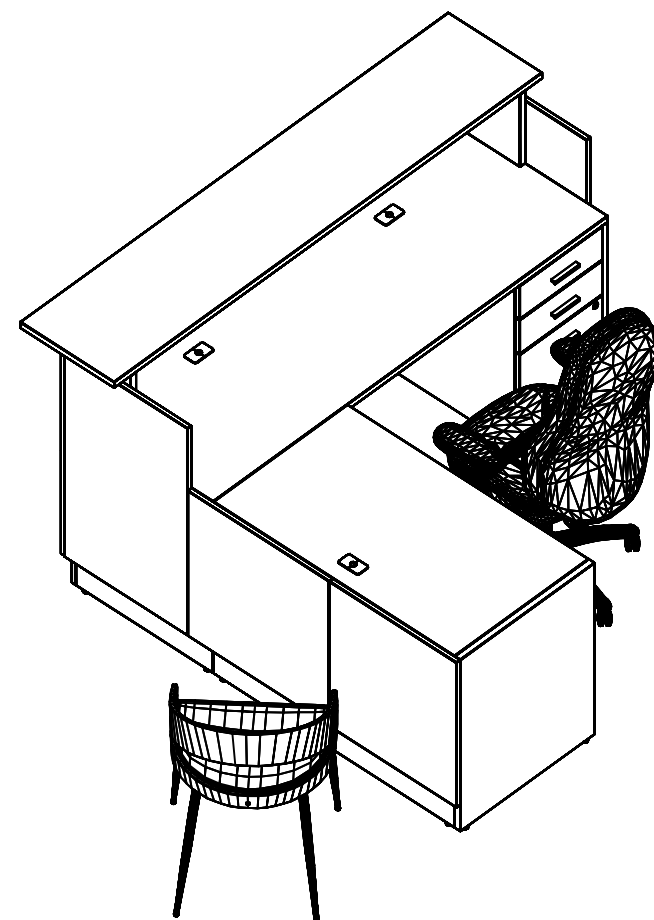
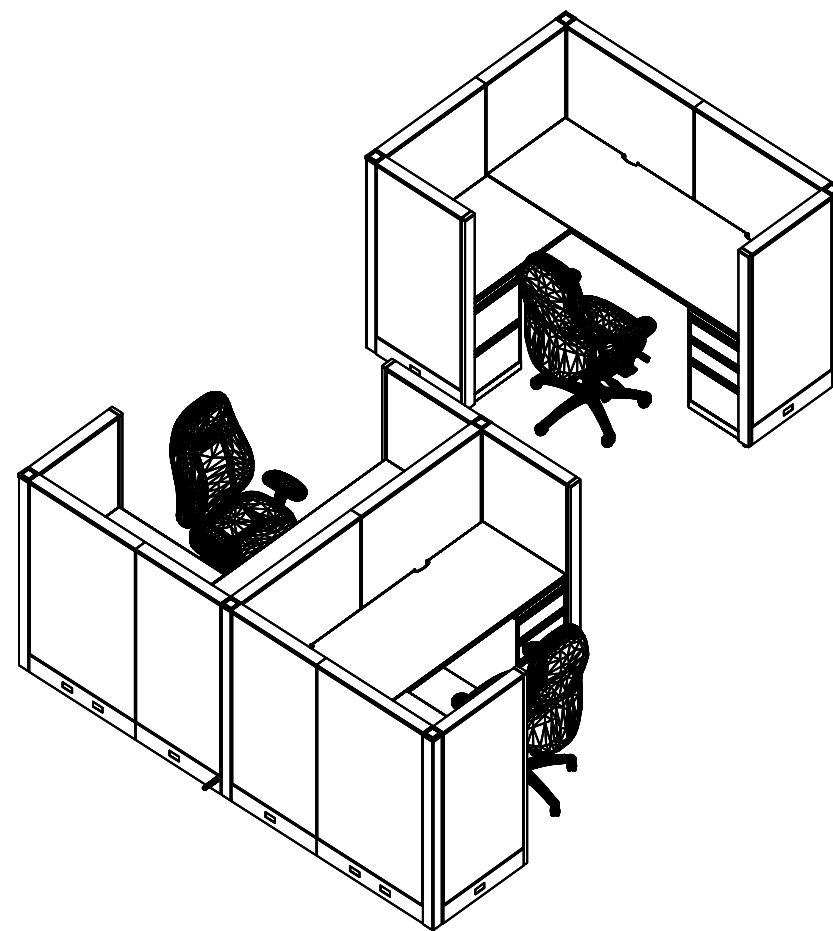

NOTE:

- DEALER TO FIELD MEASURE AND VERIFY ALL COMPONENTS FIT WITHIN ALLOTTED AREAS
- PANELS NOT AFFIXED TO STORAGE OR SURFACES CAN SHOW MOVEMENT
- BASEFEEDS REQUIRE 3" OF SPACE
- DEALER TO CONFIRM BASEFEED LOCATIONS

DRAWN TO DEALER PROVIDED SPECIFICATIONS. THE GLOBAL GROUP OF COMPANIES IS NOT RESPONSIBLE FOR THE OVERALL ACCURACY OF ROOM DIMENSIONS, COLUMNS, DOORWAYS, WINDOWS, OBSTRUCTIONS, ETC. THIS RENDERING IS BEING PROVIDED TO YOU IN CONJUNCTION WITH THE PROSPECTIVE RETAIL SALE OF PRODUCTS AND IS FOR INFORMATIONAL PURPOSES ONLY. THE GLOBAL GROUP OF COMPANIES IS NOT A LICENSED INTERIOR DESIGNER OR ARCHITECT.

CITY OF MOORE CITY HALL
AREA C - 118 OPEN OFFICE
MERRIFIELD OFFICE SUPPLY

SPECIFICATION DEPARTMENT
global furniture group
globalfurnituregroup.com
globaladpartalia.com
evolvefurnituregroup.com



PREPARED BY
BJ
DATE
5.01.24
PROJECT NUMBER
S93706
REVISION
18

SHEET
2
SCALE = NTS

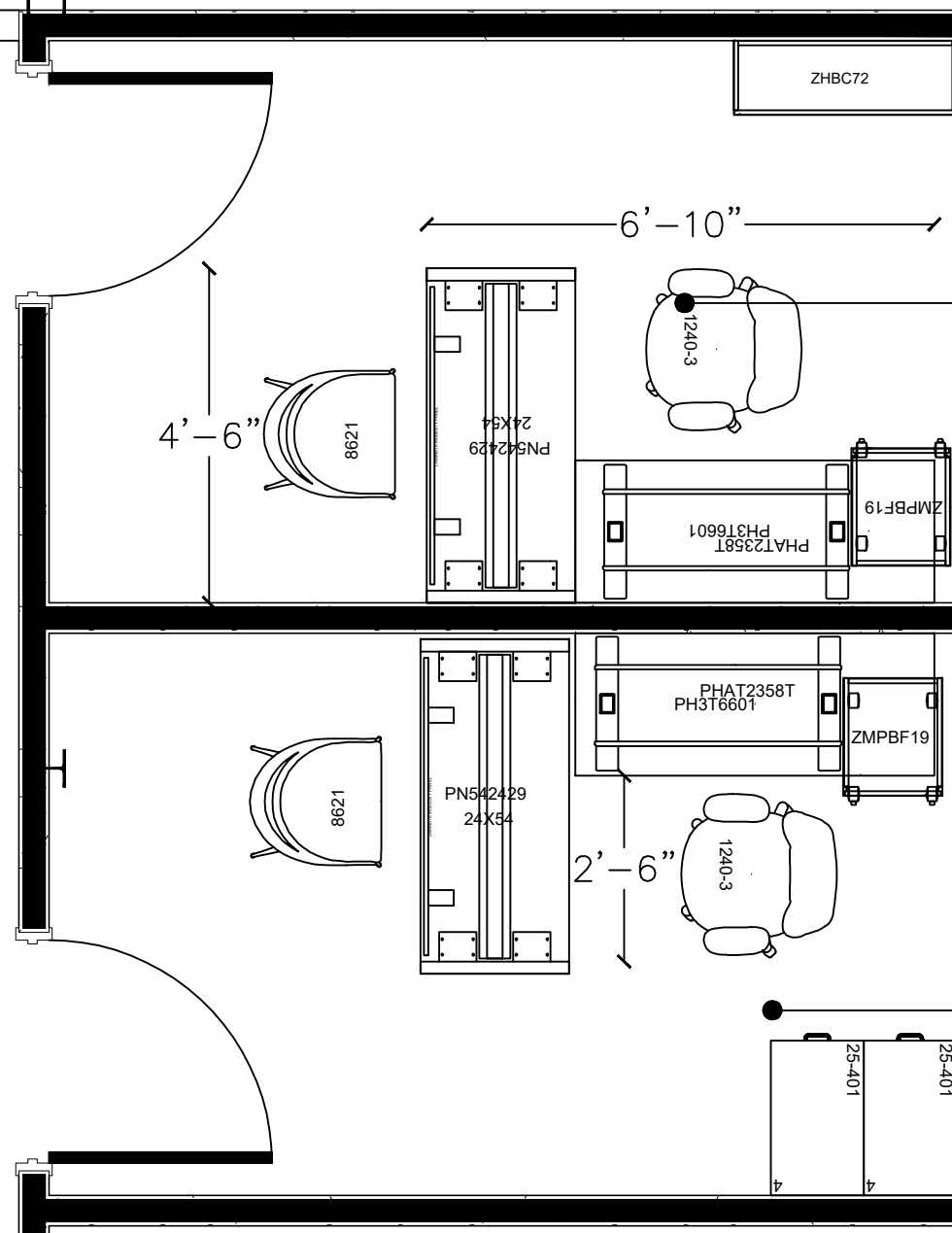

OFFICE
114

92
SF

OFFICE
115

92
SF

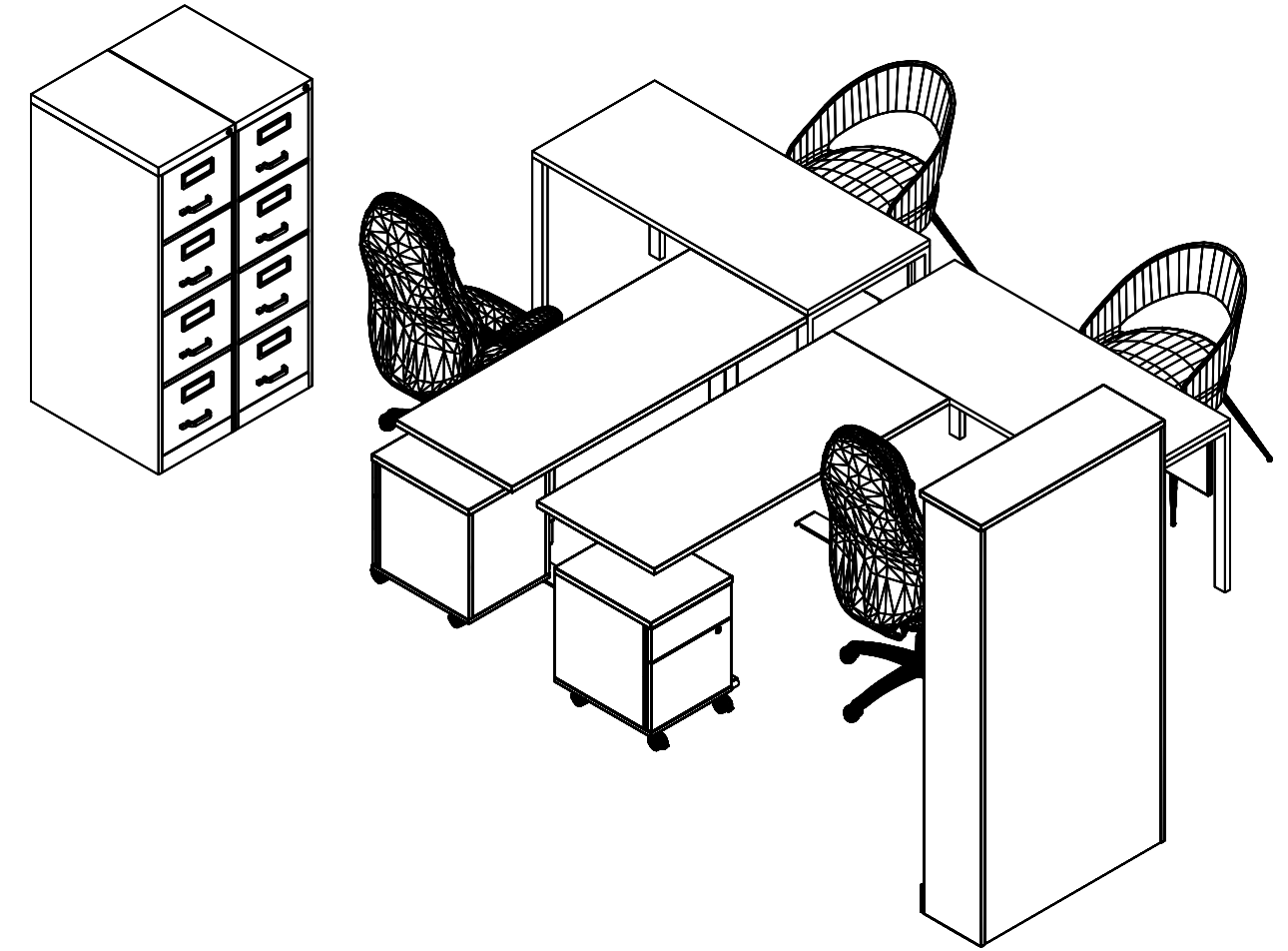
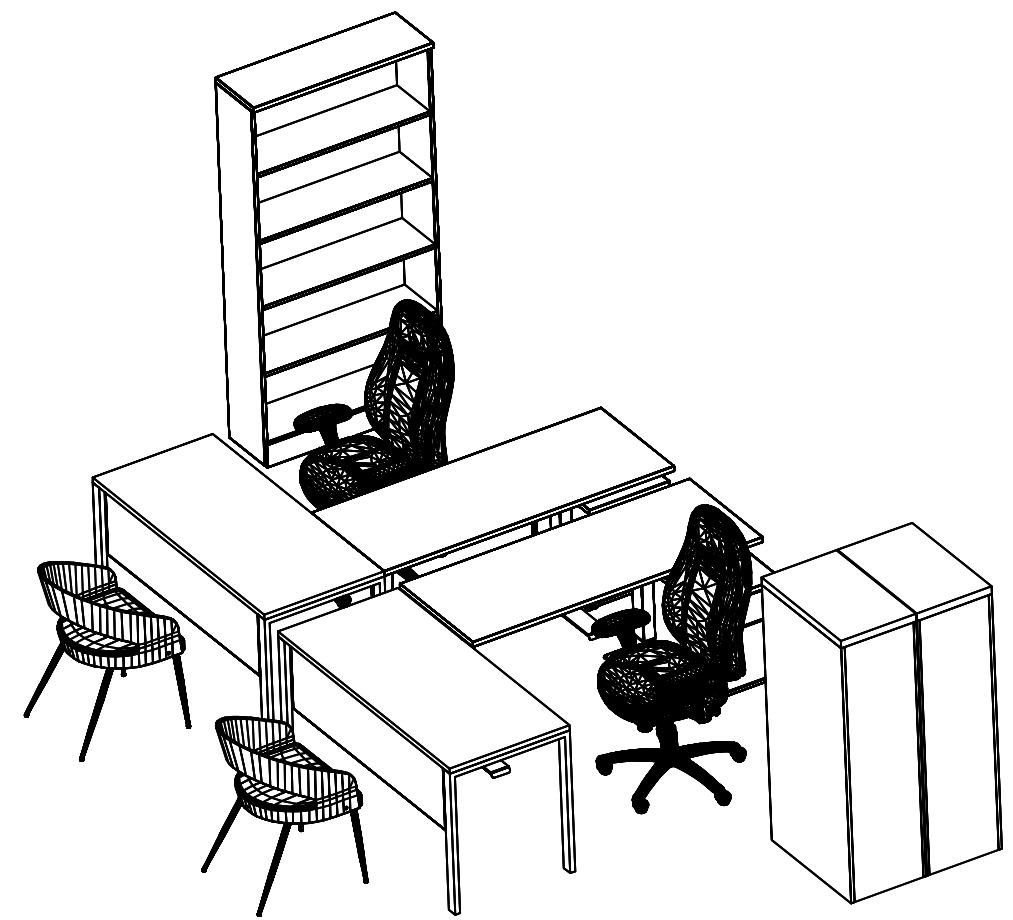

CITY OF MOORE CITY HALL
AREA C – 114 & 115 OFFICES
MERRIFIELD OFFICE SUPPLY

SPECIFICATION DEPARTMENT
global furniture group
globalfurnituregroup.com
globaladpartalia.com
evolvefurnituregroup.com



PREPARED BY
BJ
DATE
5.01.24
PROJECT NUMBER
S93706
REVISION
18

SHEET
3
SCALE = NTS

NOTE:
• DEALER TO FIELD MEASURE AND VERIFY ALL COMPONENTS FIT WITHIN ALLOTTED AREAS

DRAWN TO DEALER PROVIDED SPECIFICATIONS. THE GLOBAL GROUP OF COMPANIES IS NOT RESPONSIBLE FOR THE OVERALL ACCURACY OF ROOM DIMENSIONS, COLUMNS, DOORWAYS, WINDOWS, OBSTRUCTIONS, ETC. THIS RENDERING IS BEING PROVIDED TO YOU IN CONJUNCTION WITH THE PROSPECTIVE RETAIL SALE OF PRODUCTS AND IS FOR INFORMATIONAL PURPOSES ONLY. THE GLOBAL GROUP OF COMPANIES IS NOT A LICENSED INTERIOR DESIGNER OR ARCHITECT.

COUNCIL CHAMBER

126

CORRIDOR

111

31'-6 1/2"

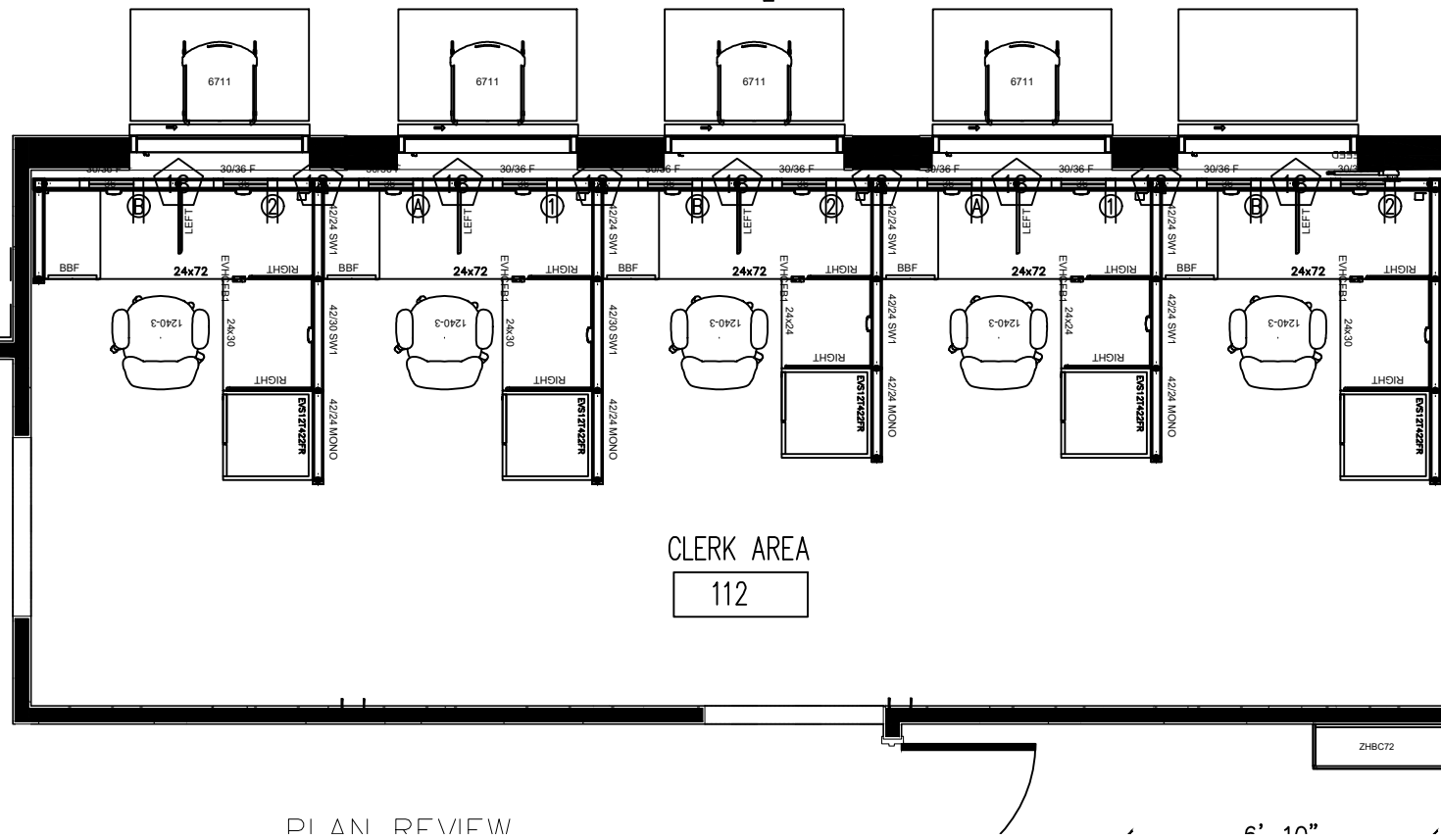

CLERK AREA

112

PLAN REVIEW

6' 10"

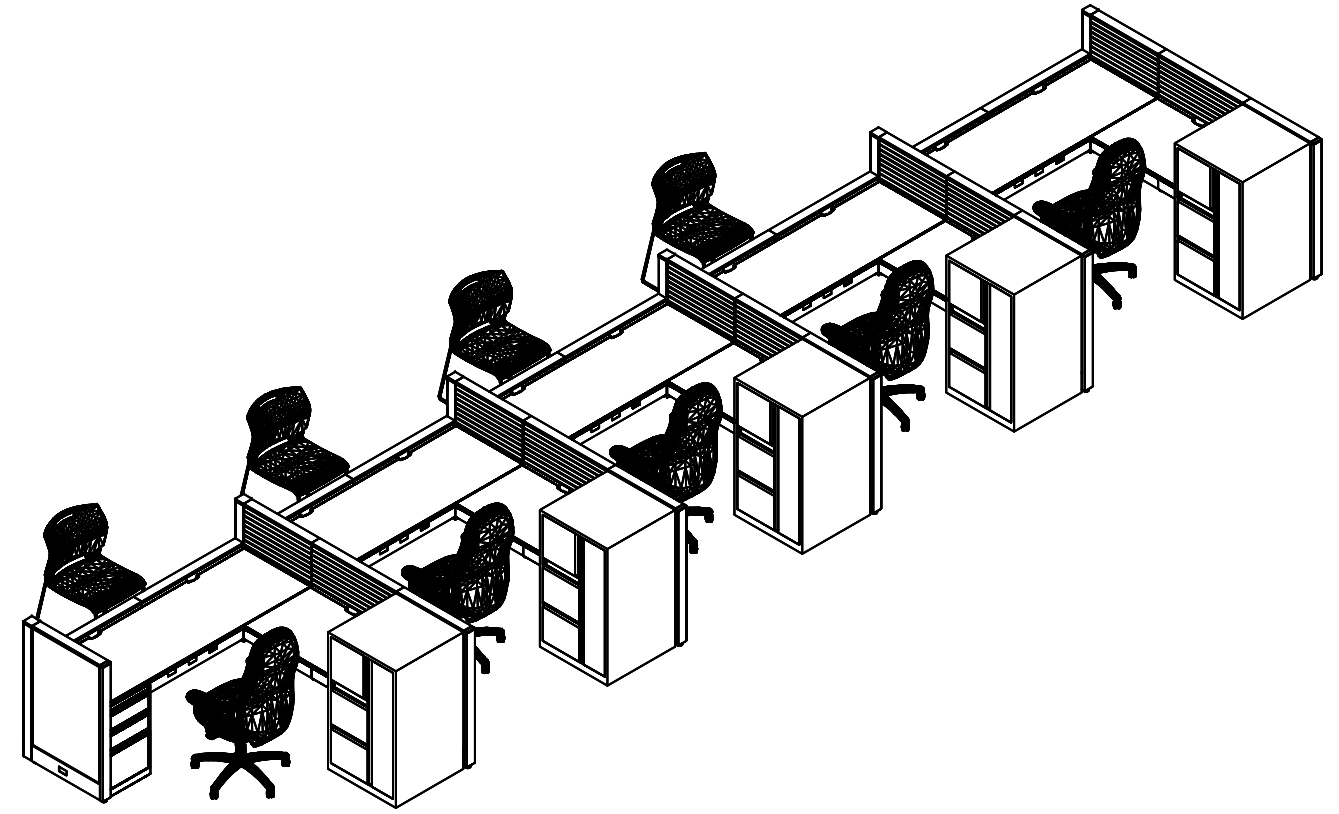

CITY OF MOORE CITY HALL
AREA C - 112 CLERK
MERRIFIELD OFFICE SUPPLY

SPECIFICATION DEPARTMENT
global furniture group
globalfurnituregroup.com
globalADpartalia.com
evolvefurnituregroup.com



PREPARED BY
BJ
DATE
5.01.24
PROJECT NUMBER
S93706
REVISION
18

SHEET
4
SCALE = NTS

- NOTE:
- DEALER TO FIELD MEASURE AND VERIFY ALL COMPONENTS FIT WITHIN ALLOTTED AREAS
 - PANELS NOT AFFIXED TO STORAGE OR SURFACES CAN SHOW MOVEMENT
 - BASEFEEDS REQUIRE 3" OF SPACE
 - DEALER TO CONFIRM BASEFEED LOCATION.

DRAWN TO DEALER PROVIDED SPECIFICATIONS. THE GLOBAL GROUP OF COMPANIES IS NOT RESPONSIBLE FOR THE OVERALL ACCURACY OF ROOM DIMENSIONS, COLUMNS, DOORWAYS, WINDOWS, OBSTRUCTIONS, ETC. THIS RENDERING IS BEING PROVIDED TO YOU IN CONJUNCTION WITH THE PROSPECTIVE RETAIL SALE OF PRODUCTS AND IS FOR INFORMATIONAL PURPOSES ONLY. THE GLOBAL GROUP OF COMPANIES IS NOT A LICENSED INTERIOR DESIGNER OR ARCHITECT.

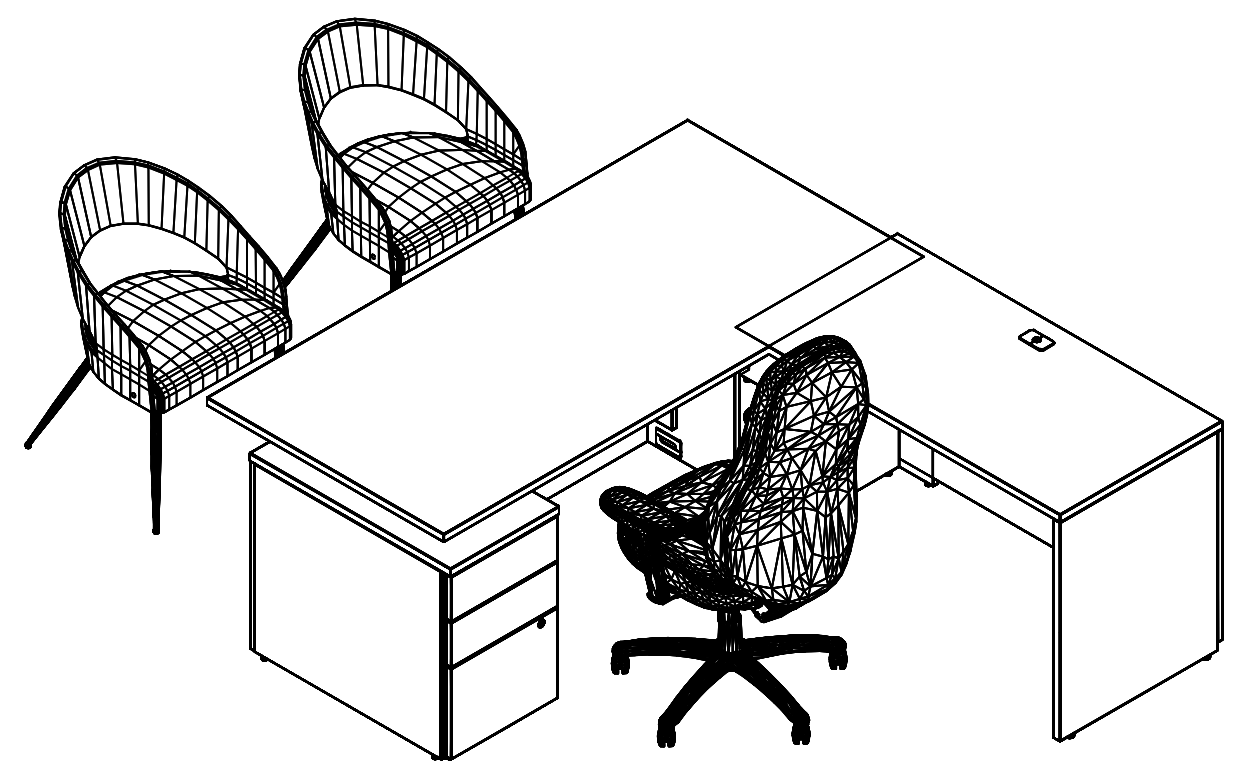
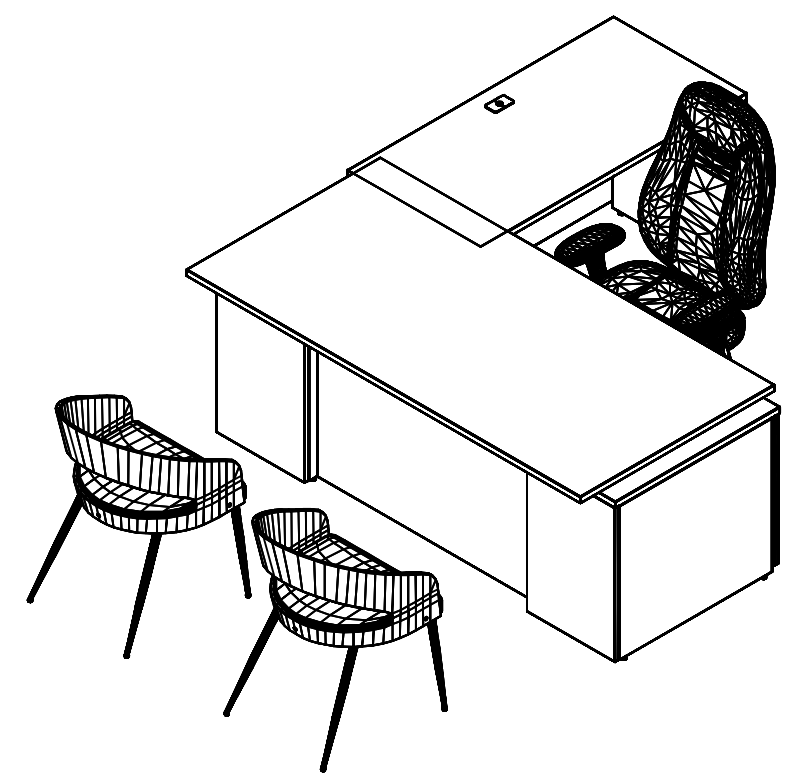
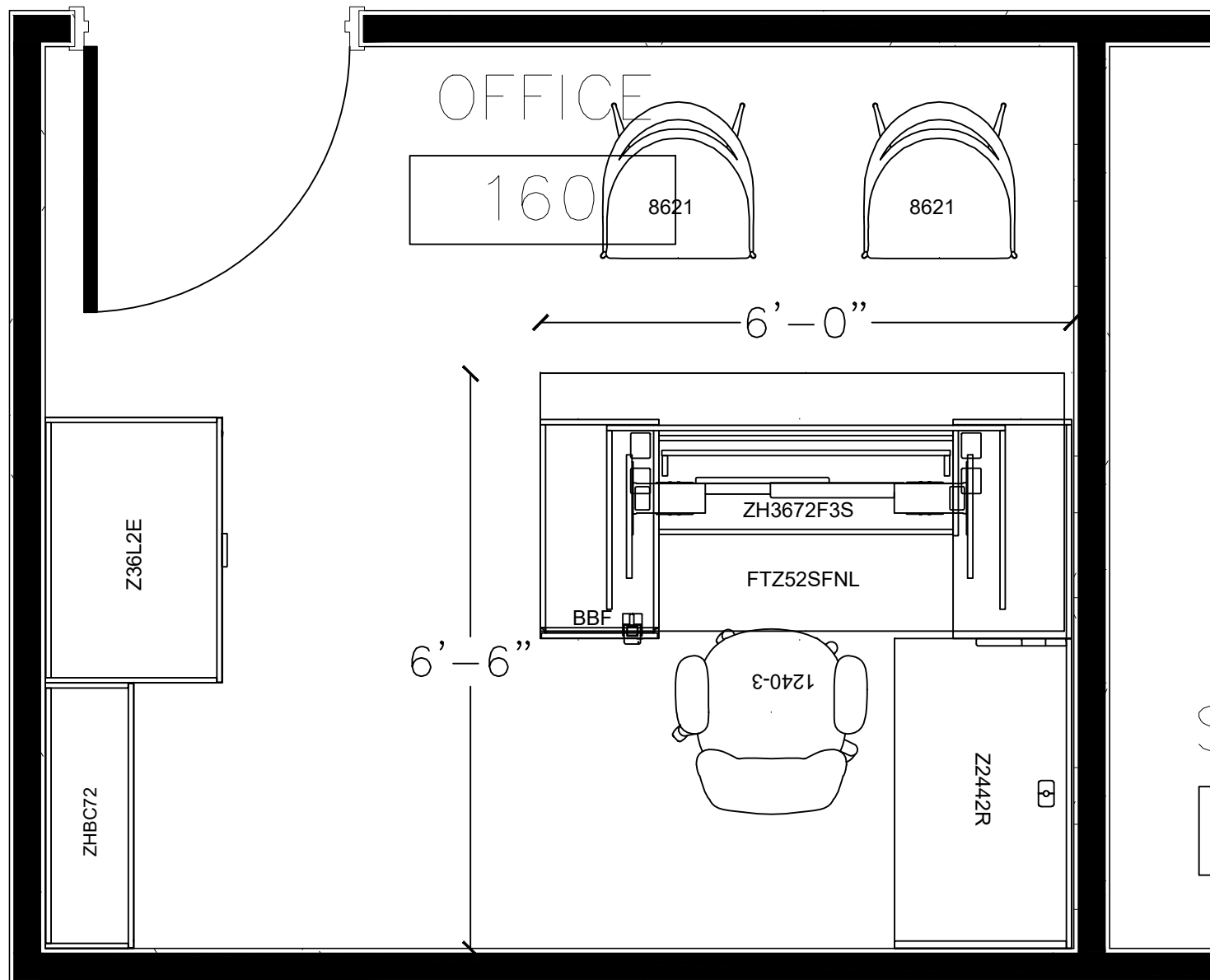

CITY OF MOORE CITY HALL
OFFICE L-TYPICAL
MERRIFIELD OFFICE SUPPLY

SPECIFICATION DEPARTMENT
global furniture group
globalfurnituregroup.com
globaladpartalia.com
evolvefurnituregroup.com



PREPARED BY
BJ
DATE
5.01.24
PROJECT NUMBER
S93706
REVISION
18

SHEET
5
SCALE = NTS

NOTE:
 • DEALER TO FIELD MEASURE AND VERIFY ALL COMPONENTS FIT WITHIN ALLOTTED AREAS
 • EXACT RETURN SIZING AND STORAGE VARIES PER OFFICE – SEE PLAN VIEW

DRAWN TO DEALER PROVIDED SPECIFICATIONS. THE GLOBAL GROUP OF COMPANIES IS NOT RESPONSIBLE FOR THE OVERALL ACCURACY OF ROOM DIMENSIONS, COLUMNS, DOORWAYS, WINDOWS, OBSTRUCTIONS, ETC. THIS RENDERING IS BEING PROVIDED TO YOU IN CONJUNCTION WITH THE PROSPECTIVE RETAIL SALE OF PRODUCTS AND IS FOR INFORMATIONAL PURPOSES ONLY. THE GLOBAL GROUP OF COMPANIES IS NOT A LICENSED INTERIOR DESIGNER OR ARCHITECT.

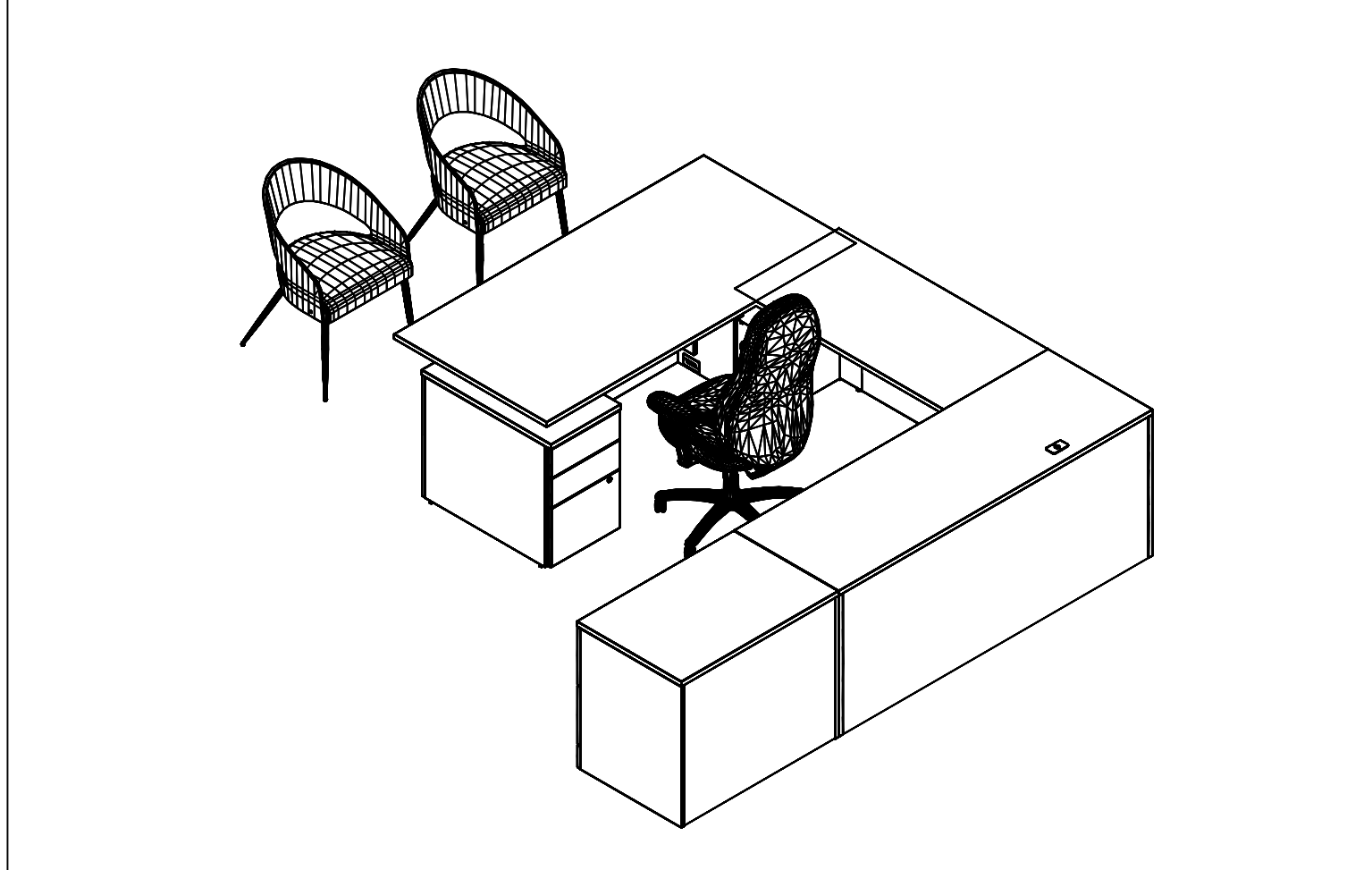
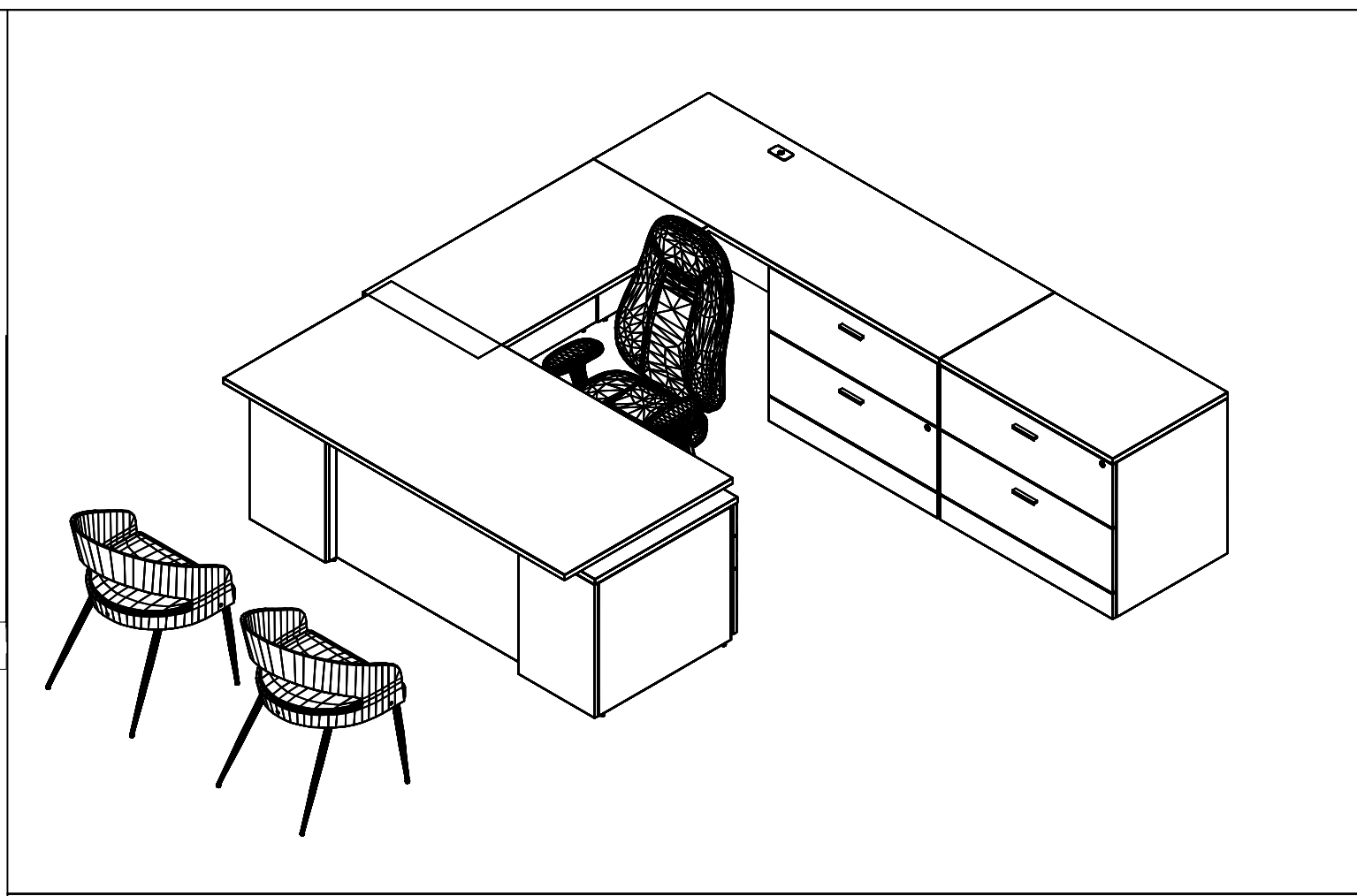
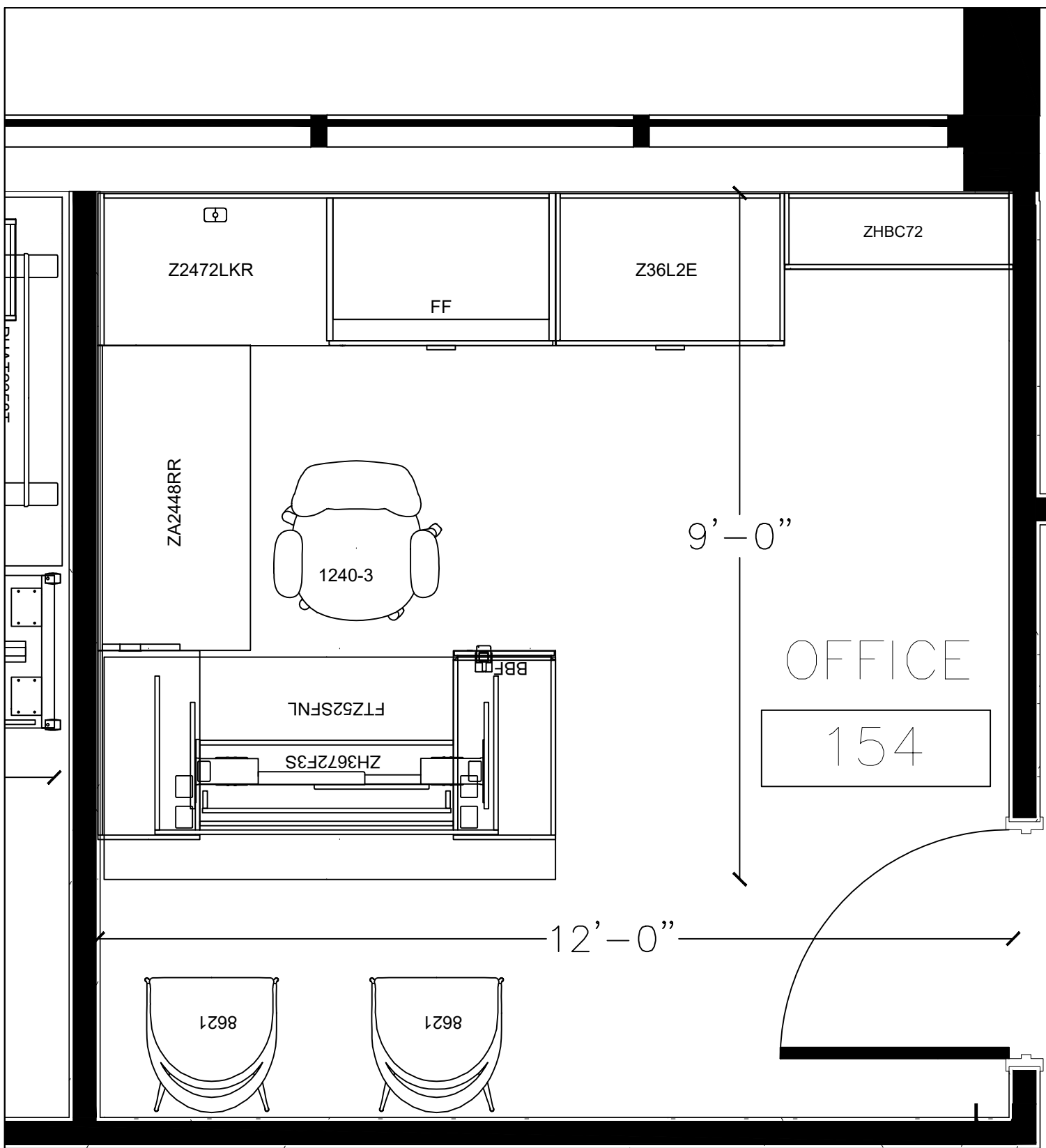

CITY OF MOORE CITY HALL
 OFFICE U-TYPICAL w/LATERAL
 MERRIFIELD OFFICE SUPPLY

SPECIFICATION DEPARTMENT
 global furniture group
 globalfurnituregroup.com
 globaladpartalia.com
 evolvefurnituregroup.com



PREPARED BY
 BJ
 DATE
 5.01.24
 PROJECT NUMBER
 S93706
 REVISION
 18

SHEET
 6
 SCALE = NTS

NOTE:
 • DEALER TO FIELD MEASURE AND VERIFY ALL COMPONENTS FIT WITHIN ALLOTTED AREAS
 • EXACT BRIDGE SIZING AND STORAGE VARIES PER OFFICE – SEE PLAN VIEW

DRAWN TO DEALER PROVIDED SPECIFICATIONS. THE GLOBAL GROUP OF COMPANIES IS NOT RESPONSIBLE FOR THE OVERALL ACCURACY OF ROOM DIMENSIONS, COLUMNS, DOORWAYS, WINDOWS, OBSTRUCTIONS, ETC. THIS RENDERING IS BEING PROVIDED TO YOU IN CONJUNCTION WITH THE PROSPECTIVE RETAIL SALE OF PRODUCTS AND IS FOR INFORMATIONAL PURPOSES ONLY. THE GLOBAL GROUP OF COMPANIES IS NOT A LICENSED INTERIOR DESIGNER OR ARCHITECT.

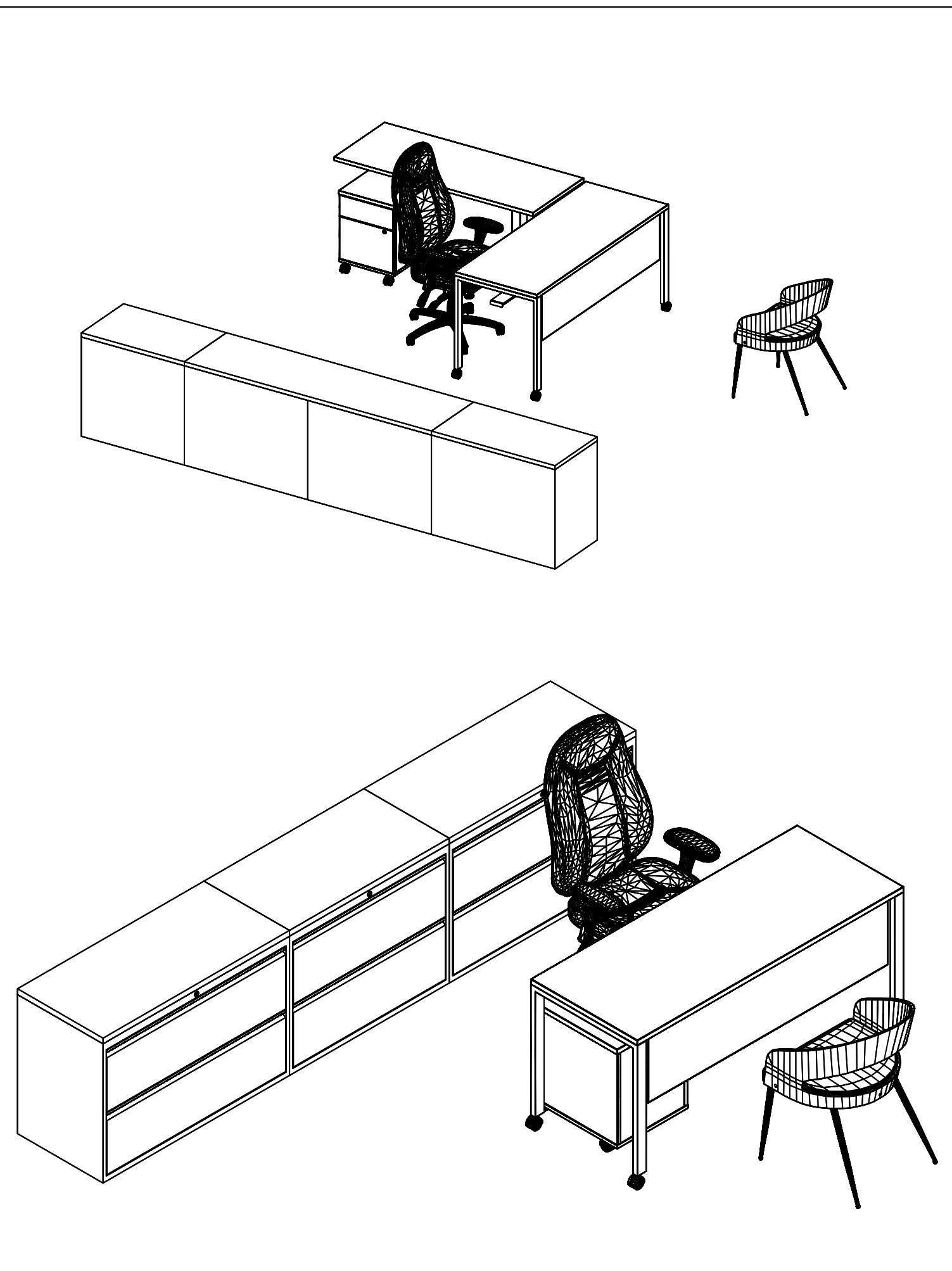
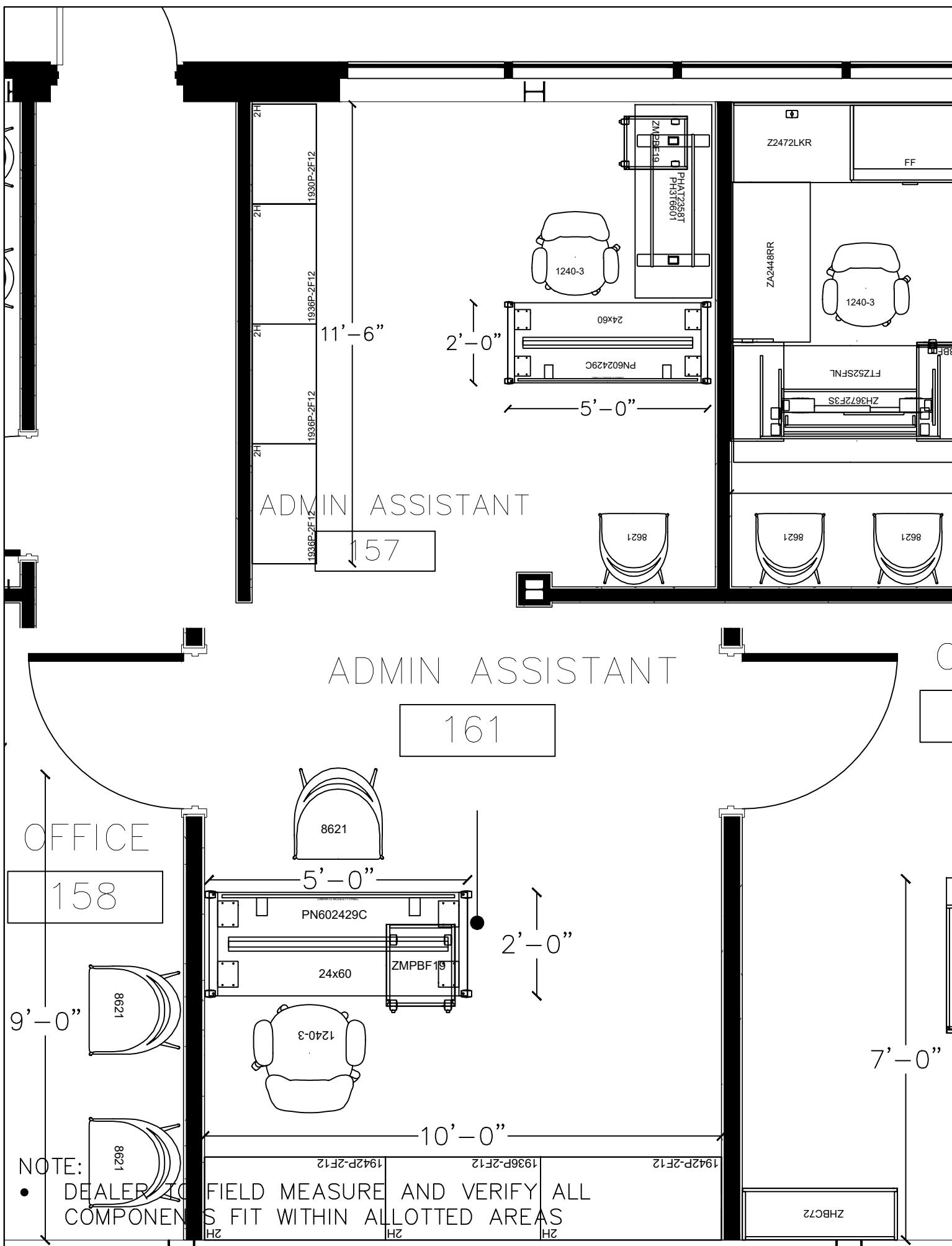

CITY OF MOORE CITY HALL
 ADMIN ASST TYPICAL
 MERRIFIELD OFFICE SUPPLY

SPECIFICATION DEPARTMENT
 global furniture group
 globalfurnituregroup.com
 globaladpartalia.com
 evolvefurnituregroup.com



PREPARED BY
 BJ
 DATE
 5.01.24
 PROJECT NUMBER
 S93706
 REVISION
 18

SHEET
 7
 SCALE = NTS

DRAWN TO DEALER PROVIDED SPECIFICATIONS. THE GLOBAL GROUP OF COMPANIES IS NOT RESPONSIBLE FOR THE OVERALL ACCURACY OF ROOM DIMENSIONS, COLUMNS, DOORWAYS, WINDOWS, OBSTRUCTIONS, ETC. THIS RENDERING IS BEING PROVIDED TO YOU IN CONJUNCTION WITH THE PROSPECTIVE RETAIL SALE OF PRODUCTS AND IS FOR INFORMATIONAL PURPOSES ONLY. THE GLOBAL GROUP OF COMPANIES IS NOT A LICENSED INTERIOR DESIGNER OR ARCHITECT.

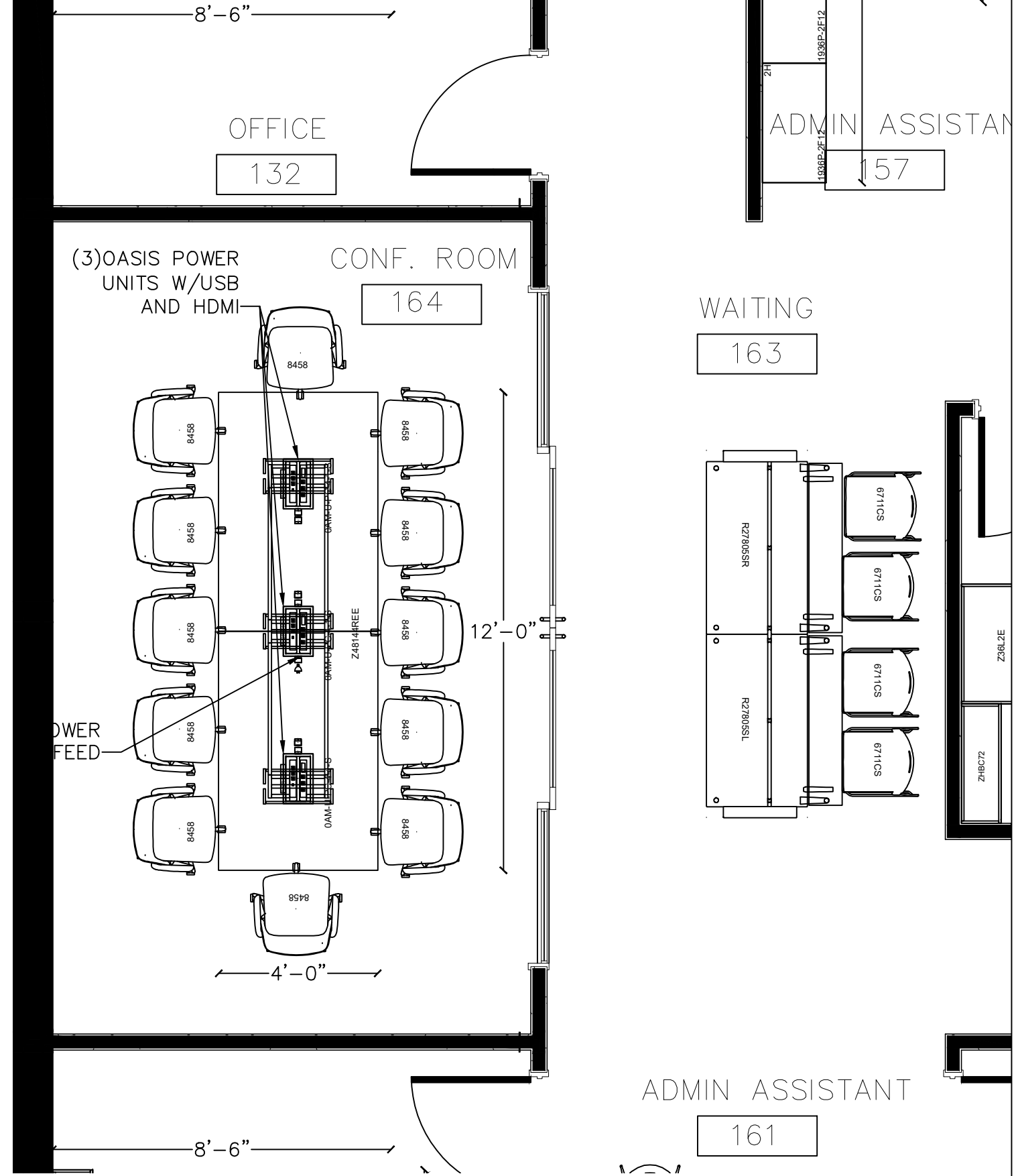

CITY OF MOORE CITY HALL
 AREA B - 163 & 134 CONFERENCE/WAITING
 MERRIFIELD OFFICE SUPPLY

SPECIFICATION DEPARTMENT
 global furniture group
 globalfurnituregroup.com
 globaladpartalia.com
 evolvefurnituregroup.com



PREPARED BY
 BJ
 DATE
 5.01.24
 PROJECT NUMBER
 S93706
 REVISION
 18

SHEET
 8
 SCALE = NTS

- NOTE:
- DEALER TO FIELD MEASURE AND VERIFY ALL COMPONENTS FIT WITHIN ALLOTTED AREAS
 - CONFERENCE ARMS NOT SHOWN IN 3D VIEW

DRAWN TO DEALER PROVIDED SPECIFICATIONS. THE GLOBAL GROUP OF COMPANIES IS NOT RESPONSIBLE FOR THE OVERALL ACCURACY OF ROOM DIMENSIONS, COLUMNS, DOORWAYS, WINDOWS, OBSTRUCTIONS, ETC. THIS RENDERING IS BEING PROVIDED TO YOU IN CONJUNCTION WITH THE PROSPECTIVE RETAIL SALE OF PRODUCTS AND IS FOR INFORMATIONAL PURPOSES ONLY. THE GLOBAL GROUP OF COMPANIES IS NOT A LICENSED INTERIOR DESIGNER OR ARCHITECT.

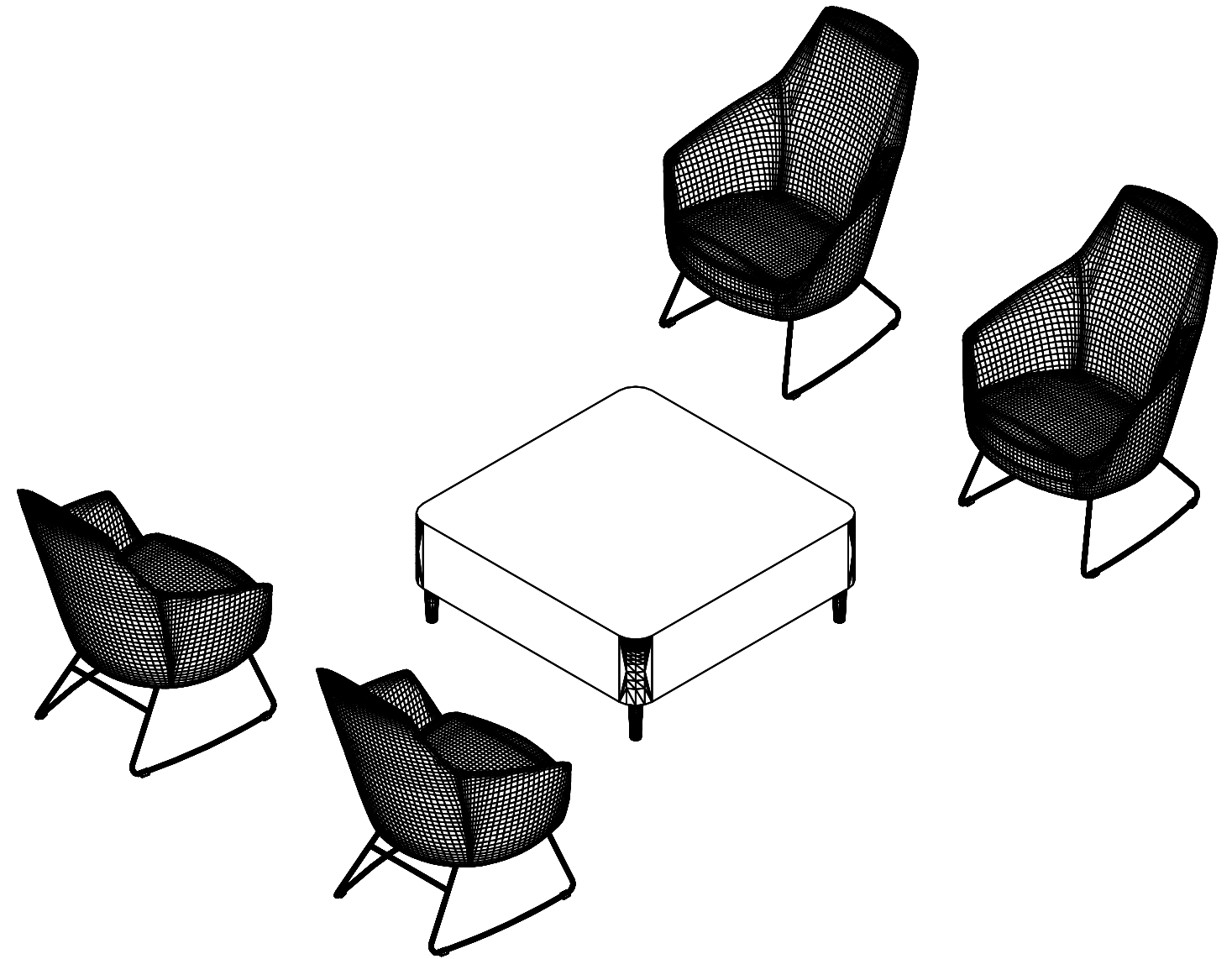
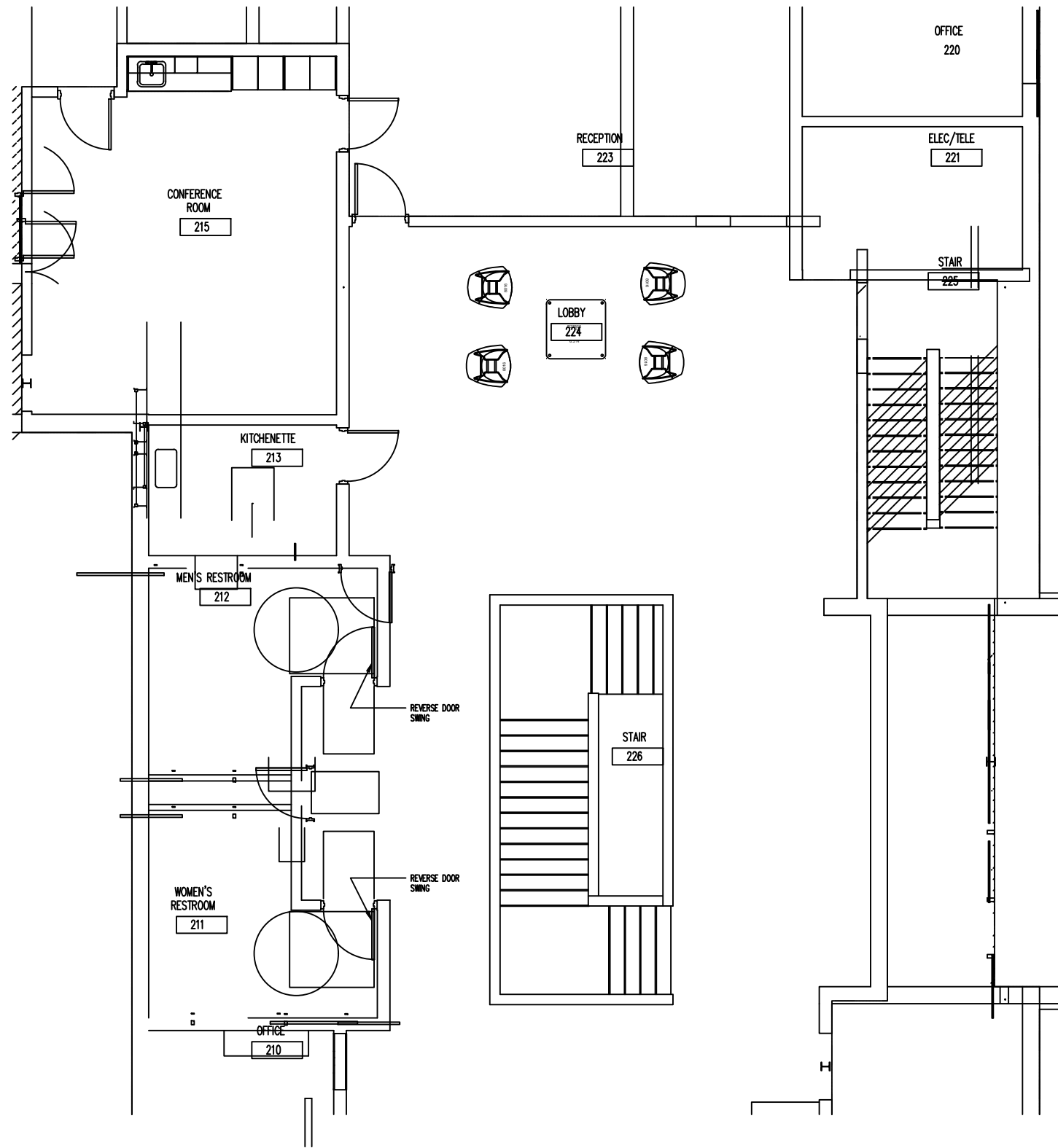

CITY OF MOORE CITY HALL
 AREA E – OVERALL & LOBBY
 MERRIFIELD OFFICE SUPPLY

SPECIFICATION DEPARTMENT
 global furniture group
 globalfurnituregroup.com
 globaladpartalia.com
 evolvefurnituregroup.com



PREPARED BY
 BJ
 DATE
 5.01.24
 PROJECT NUMBER
 S93706
 REVISION
 18

SHEET
 9
 SCALE = NTS

NOTE:
 • DEALER TO FIELD MEASURE AND VERIFY ALL COMPONENTS FIT WITHIN ALLOTTED AREAS

DRAWN TO DEALER PROVIDED SPECIFICATIONS. THE GLOBAL GROUP OF COMPANIES IS NOT RESPONSIBLE FOR THE OVERALL ACCURACY OF ROOM DIMENSIONS, COLUMNS, DOORWAYS, WINDOWS, OBSTRUCTIONS, ETC. THIS RENDERING IS BEING PROVIDED TO YOU IN CONJUNCTION WITH THE PROSPECTIVE RETAIL SALE OF PRODUCTS AND IS FOR INFORMATIONAL PURPOSES ONLY. THE GLOBAL GROUP OF COMPANIES IS NOT A LICENSED INTERIOR DESIGNER OR ARCHITECT.

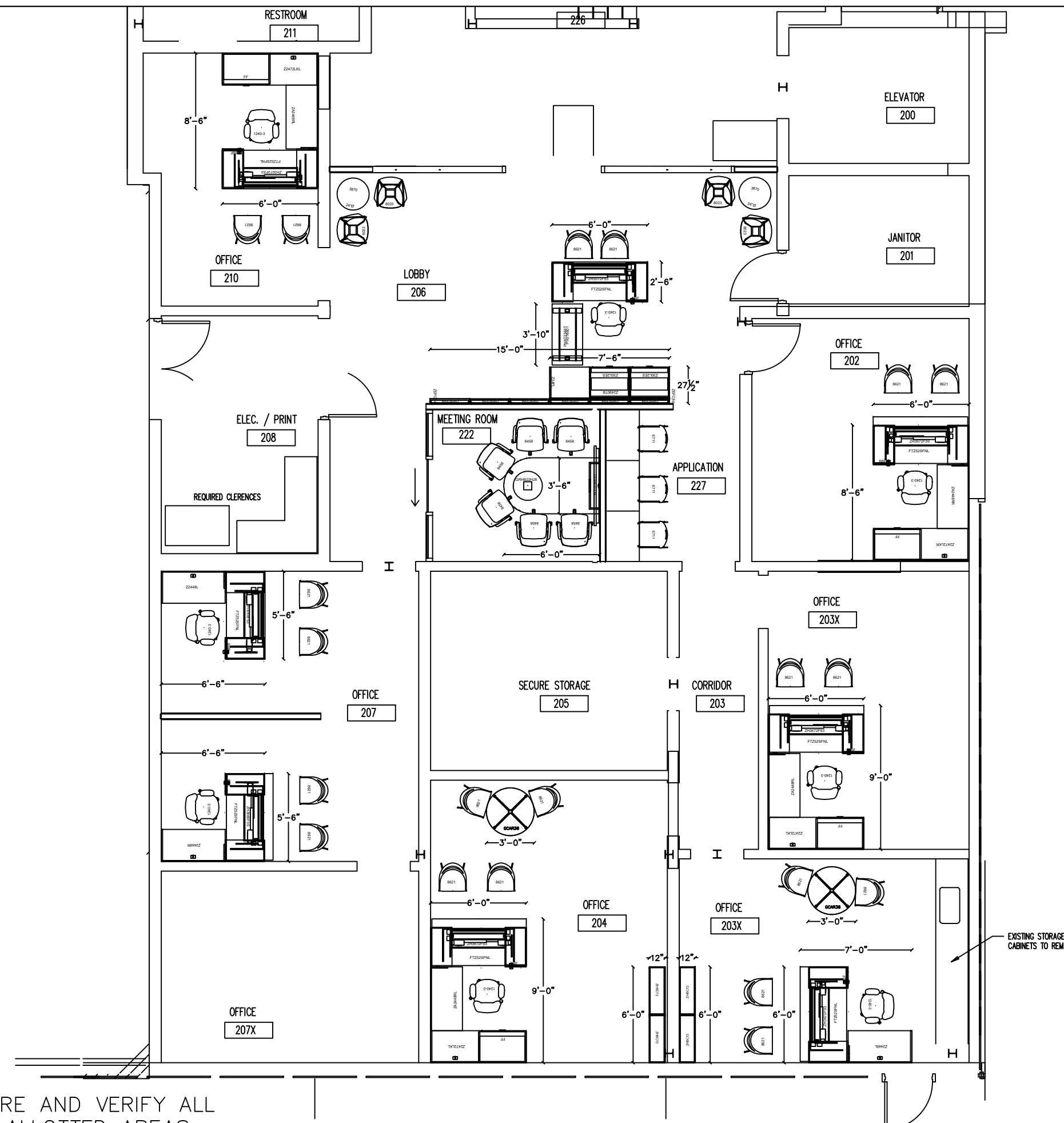

NOTE:
 • DEALER TO FIELD MEASURE AND VERIFY ALL COMPONENTS FIT WITHIN ALLOTTED AREAS

DRAWN TO DEALER PROVIDED SPECIFICATIONS. THE GLOBAL GROUP OF COMPANIES IS NOT RESPONSIBLE FOR THE OVERALL ACCURACY OF ROOM DIMENSIONS, COLUMNS, DOORWAYS, WINDOWS, OBSTRUCTIONS, ETC. THIS RENDERING IS BEING PROVIDED TO YOU IN CONJUNCTION WITH THE PROSPECTIVE RETAIL SALE OF PRODUCTS AND IS FOR INFORMATIONAL PURPOSES ONLY. THE GLOBAL GROUP OF COMPANIES IS NOT A LICENSED INTERIOR DESIGNER OR ARCHITECT.

CITY OF MOORE CITY HALL
 AREA F – OVERALL
 MERRIFIELD OFFICE SUPPLY

SPECIFICATION DEPARTMENT
 global furniture group
 globalfurnituregroup.com
 globaladpartalia.com
 evolvefurnituregroup.com



PREPARED BY
 BJ
 DATE
 5.01.24
 PROJECT NUMBER
 S93706
 REVISION
 18

SHEET
 10
 SCALE = NTS

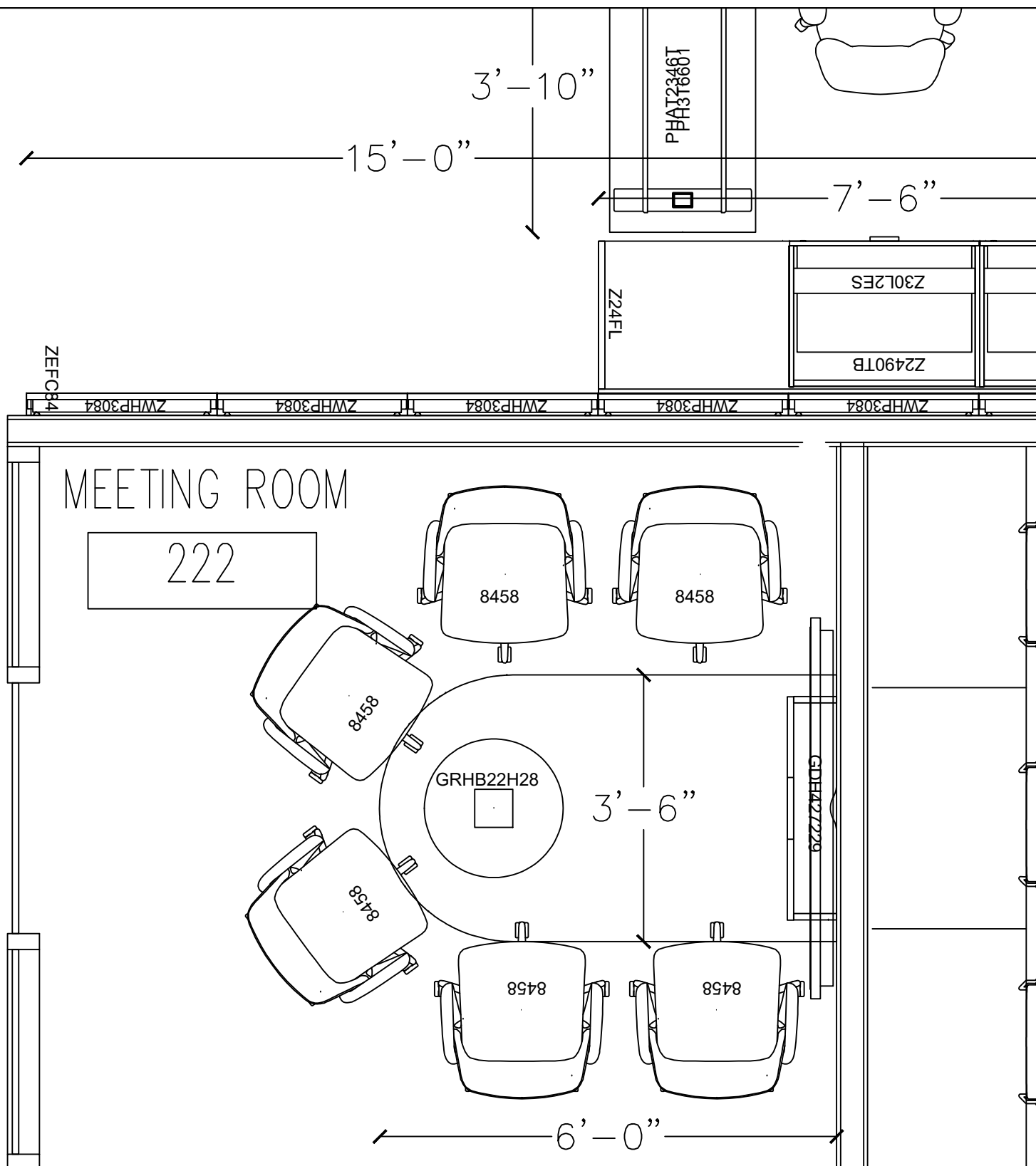

CITY OF MOORE CITY HALL
 AREA F - 222 MEETING
 MERRIFIELD OFFICE SUPPLY

SPECIFICATION DEPARTMENT
 global furniture group
 globalfurnituregroup.com
 globaladpartalia.com
 evolvefurnituregroup.com



PREPARED BY
 BJ
 DATE
 5.01.24
 PROJECT NUMBER
 S93706
 REVISION
 18

SHEET
 11
 SCALE = NTS

NOTE:

- DEALER TO FIELD MEASURE AND VERIFY ALL COMPONENTS FIT WITHIN ALLOTTED AREAS
- TABLE IS NOT POWERED

DRAWN TO DEALER PROVIDED SPECIFICATIONS. THE GLOBAL GROUP OF COMPANIES IS NOT RESPONSIBLE FOR THE OVERALL ACCURACY OF ROOM DIMENSIONS, COLUMNS, DOORWAYS, WINDOWS, OBSTRUCTIONS, ETC. THIS RENDERING IS BEING PROVIDED TO YOU IN CONJUNCTION WITH THE PROSPECTIVE RETAIL SALE OF PRODUCTS AND IS FOR INFORMATIONAL PURPOSES ONLY. THE GLOBAL GROUP OF COMPANIES IS NOT A LICENSED INTERIOR DESIGNER OR ARCHITECT.

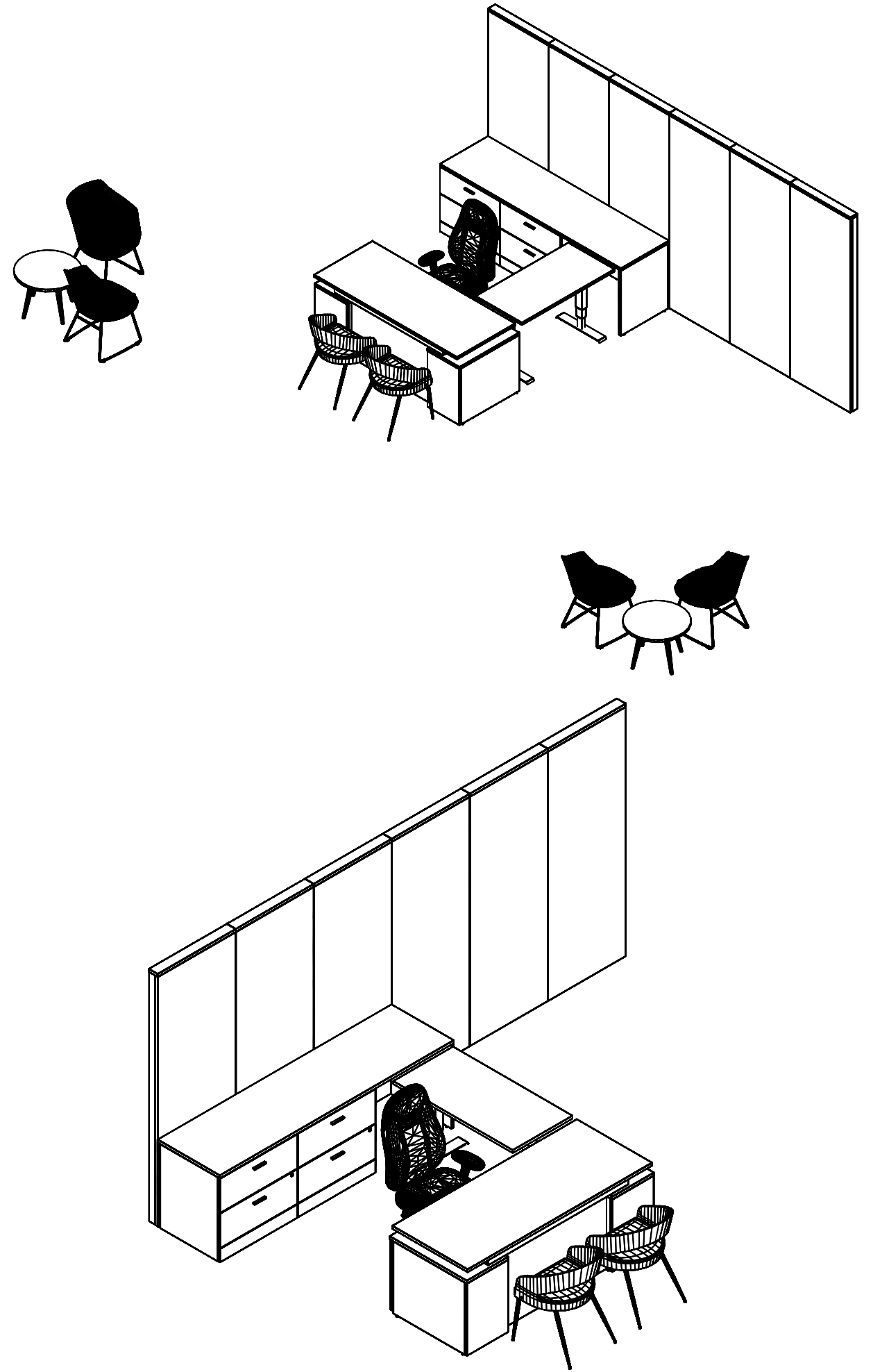
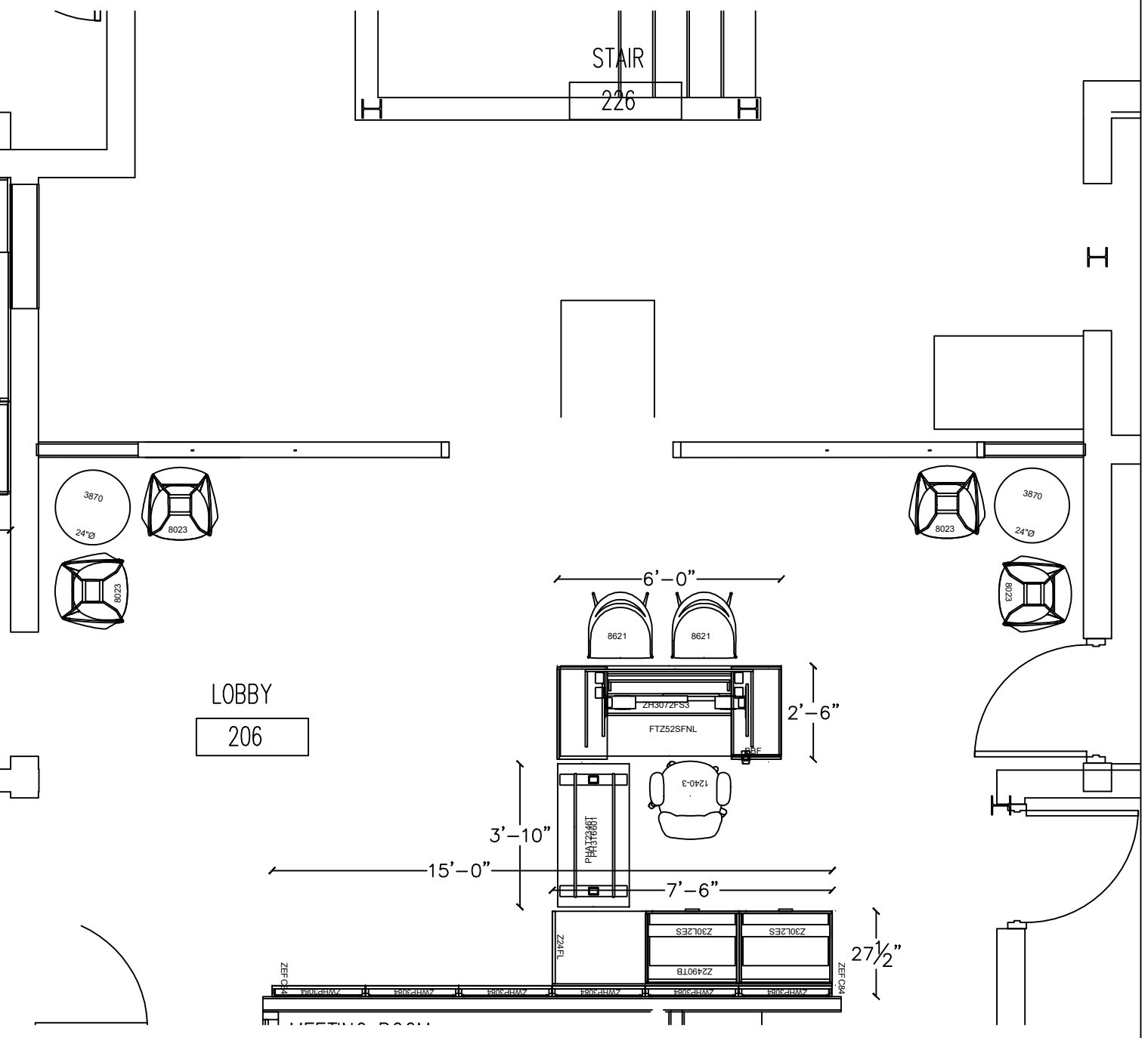

NOTE:
 • DEALER TO FIELD MEASURE AND VERIFY ALL COMPONENTS FIT WITHIN ALLOTTED AREAS

DRAWN TO DEALER PROVIDED SPECIFICATIONS. THE GLOBAL GROUP OF COMPANIES IS NOT RESPONSIBLE FOR THE OVERALL ACCURACY OF ROOM DIMENSIONS, COLUMNS, DOORWAYS, WINDOWS, OBSTRUCTIONS, ETC. THIS RENDERING IS BEING PROVIDED TO YOU IN CONJUNCTION WITH THE PROSPECTIVE RETAIL SALE OF PRODUCTS AND IS FOR INFORMATIONAL PURPOSES ONLY. THE GLOBAL GROUP OF COMPANIES IS NOT A LICENSED INTERIOR DESIGNER OR ARCHITECT.